



10x4 DVI Dual Link Matrix

GEF-DVI-1044DL

User Manual

ASKING FOR ASSISTANCE

Technical Support:

Telephone (818) 772-9100
(800) 545-6900

Fax (818) 772-9120

Technical Support Hours:

8:00 AM - 5:00 PM Monday - Friday, Pacific Time

For 24 / 7 support, see the back of the product for the support number

Write To:

Gefen, LLC
c/o Customer Service
20600 Nordhoff St
Chatsworth, CA 91311

www.gefenpro.com
support@gefenpro.com

Notice

Gefen, LLC reserves the right to make changes in the hardware, packaging, and any accompanying documentation without prior written notice.

10x4 DVI Dual Link Matrix is a trademark of Gefen LLC

© 2011 Gefen, LLC. All rights reserved.
All trademarks are the property of their respective owners.

CONTENTS

1	Introduction
2	Operation Notes
3	Features
4	Front Panel Layout
5	Front Panel Descriptions
6	Back Panel Layout
7	Back Panel Descriptions
8	Connecting And Operating The 10x4 DVI Dual Link Matrix
9	Front Panel Controls
9	Routing a Source to One Monitor
10	Routing a Source to Multiple Monitors at Once
12	Masking Outputs
13	Unmasking Outputs
14	IR Remote Description
15	IR Remote Installation
16	IR Code Configuration
17	EDID Management Feature
18	RS-232 Serial Control
18	Settings
19	EDID Management
24	IP Configuration
28	General Functions
31	Commands
33	IP Control
33	Manage EDID
37	Masking
38	Configuration
39	Backup / Restore & Power Management
40	Firmware Update
42	Rack Mount Safety Information
43	Specifications
44	Warranty
45	Licensing

INTRODUCTION

Congratulations on your purchase of the GefenPRO 10x4 DVI Dual Link Matrix. Your complete satisfaction is very important to us.

GefenPRO

In the realm of video distribution, certain features are invaluable in a commercial or broadcast environment. Accommodations such as a build-in power supply and flat black rack-mount enclosures set GefenPRO apart from our traditional products. Complex distribution units allow for professional DVI, 3G-SDI, and HDMI signals to be routed and converted easily and seamlessly, while being backed up by a renowned and dependable technical support team. Gefen invites you to explore the GefenPRO product line and hopes that you find the solution that fits your needs.

The GefenPRO 10x4 DVI Dual Link Matrix

Simplify the process of routing up to 10 DVI sources to any of 4 DVI monitors without losing quality or resolution. The GefenPRO 10x4 DVI Dual Link Matrix provides a simple, reliable, and highly effective method of streamlining any installation using multiple sources and outputs, taking the hassle out of managing multiple connections. Each DVI source is accessible at all times by any monitor using the front-panel buttons, IR remote unit, built-in RS-232 or using IP control.

How It Works

Using the supplied DVI cables, connect 10 sources to the DVI input ports on the GefenPRO 10x4 DVI Dual Link Matrix. Connect the 4 DVI monitors to the DVI outputs on the GefenPRO 10x4 DVI Dual Link Matrix. Plug in the power cord and power-on the GefenPRO 10x4 DVI Dual Link Matrix. The connected monitors will show video according to the routing selection.

NOTE: The GefenPRO 10x4 DVI Dual Link Matrix only supports DVI-D. The DVI connectors on the 10x4 DVI Dual Link Matrix have all 29 pins.

OPERATION NOTES

READ THESE NOTES BEFORE INSTALLING OR OPERATING THE GEFENPRO 10X4 DVI DUAL LINK MATRIX

- The 10x4 DVI Dual Link Matrix does not support HDCP content.
- Make sure that a DVI monitor is powered and connected to one of the DVI outputs on the 10x4 DVI Dual Link Matrix before applying power. By default, the Local EDID is read from the connected monitor and is copied to all 10 DVI inputs once the Matrix has been turned on. If a monitor is not detected by the Matrix at power-on, a default (internal) EDID of 640x480 will be used. This functionality can be disabled using the Secure Local EDID function through IP control. See page 36 for more information.
- There is no internal scaling in the 10x4 DVI Dual Link Matrix. Each monitor attached to the Matrix must be able to display the resolutions output by the source device(s). For maximum compatibility it is recommended that only one common resolution be used by each source device.
- Advanced EDID features and IP configuration features are accessible through the RS-232 serial command set.
- Routing and EDID features can be accessed using a Web browser using the built-in IP control.
- **IMPORTANT:** If the unit is installed in a closed or multi-rack assembly, do not block the ventilation holes of the enclosure.

FEATURES

Features

- Increases productivity
- Supports resolutions up to 3840x2400
- Front panel control buttons for local switching
- IP Control
- Serial RS-232 interface for remote control via a computer or control automation devices
- Discrete IR remote control
- Advanced EDID management permits uploading of custom internal or external EDID settings
- Supports DDWG standards for DVI
- Internal power supply
- Output masking command
- Standby mode
- Energy Star compliant
- Grounding pin
- IR Sensor
- IR Extender
- Power On/Off switch
- Status LCD (shows routing status)
- Rack mountable

Package Includes

- (1) GefenPRO 10x4 DVI Dual Link Matrix
- (10) 6-foot DVI cable (M-M)
- (1) IR remote control unit
- (1) AC Power Cord
- (1) User Manual

FRONT PANEL LAYOUT

Front Panel

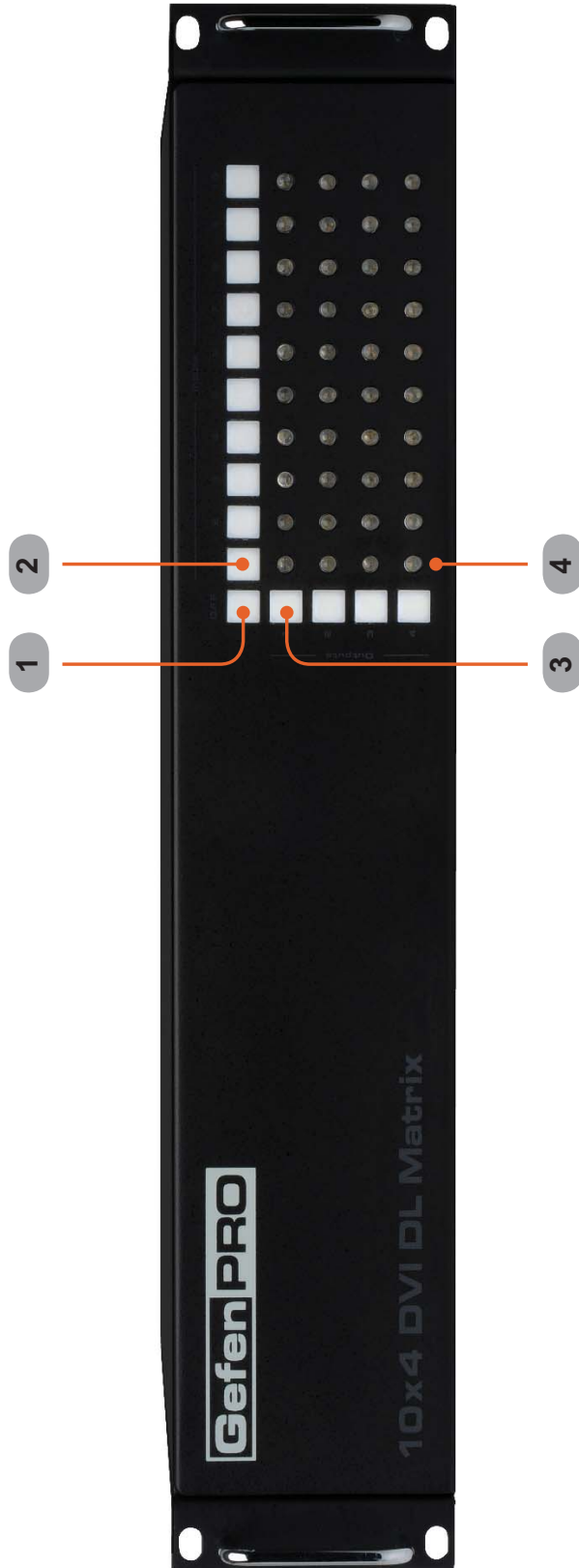

FRONT PANEL DESCRIPTIONS

Front Panel

- 1 OFF Button**
Use this button to mask selected outputs. See page 12 for details.
- 2 Input Selection Buttons (1 - 10)**
These buttons are used to select the input source.
- 3 Output Selection Buttons (1 - 4)**
These buttons are used to select the output.
- 4 Routing State Indicators**
These LED indicators show the current routing state.

BACK PANEL LAYOUT

Back Panel



BACK PANEL DESCRIPTIONS

- 1 AC 110/220V (50/60 Hz) Power Cable / Receptacle**
Connect the included AC power cord from this receptacle to an available electrical outlet..
- 2 Fuse Drawer**
Each power receptacle houses a fuse drawer. Within each fuse drawer are two (2) 250 V fuses. One fuse is active and the other is a spare.
- 3 Power Switch**
Turn the power ON or OFF using this switch. The switch will glow bright green when the Matrix is turned ON.
- 4 Grounding Terminal**
Provides a discharge path to ground in case a short circuit occurs between the “hot” lead of the power supply and the enclosure of the Matrix. The grounding wire should be attached from the grounding terminal to an approved ground path.
- 5 DVI Output Ports 1-4**
Connect DVI monitors to these ports.
- 6 DVI Input Ports 1-10**
Connect DVI source devices to these ports.
- 7 RS-232 Serial Port**
Connects to the RS-232 control device. The 10x4 DVI Dual Link Matrix may be switched remotely using this port. See page 18 for more information.

CONNECTING AND OPERATING THE 10X4 DVI DUAL LINK MATRIX

How to Connect the 10x4 DVI Dual Link Matrix

1. Connect up to 10 DVI source devices to the DVI inputs on the rear panel of the 10x4 DVI Dual Link Matrix using the supplied DVI cables.
2. Connect up to 4 DVI monitors to the DVI outputs on the rear panel of the 10x4 DVI Dual Link Matrix with user-supplied DVI cables.
3. Connect the included AC power cable to the power receptacle on the rear panel of the 10x4 DVI Dual Link Matrix. Connect the opposite end of the cable into an available electrical outlet.

How to Operate the 10x4 DVI Dual Link Matrix

The 10x4 DVI Dual Link Matrix offers a number of control options. The following methods can be used to control basic routing functions of the 10x4 DVI Dual Link Matrix:

1. Front Panel Control Buttons - Pages 9 and 13
2. IR Remote Control - Pages 14 and 16
3. RS-232 Serial Control - Pages 18 - 32
4. IP Control - Pages 33 - 39

Wiring Diagram for the GefenPRO 16x16 3GSDI Matrix

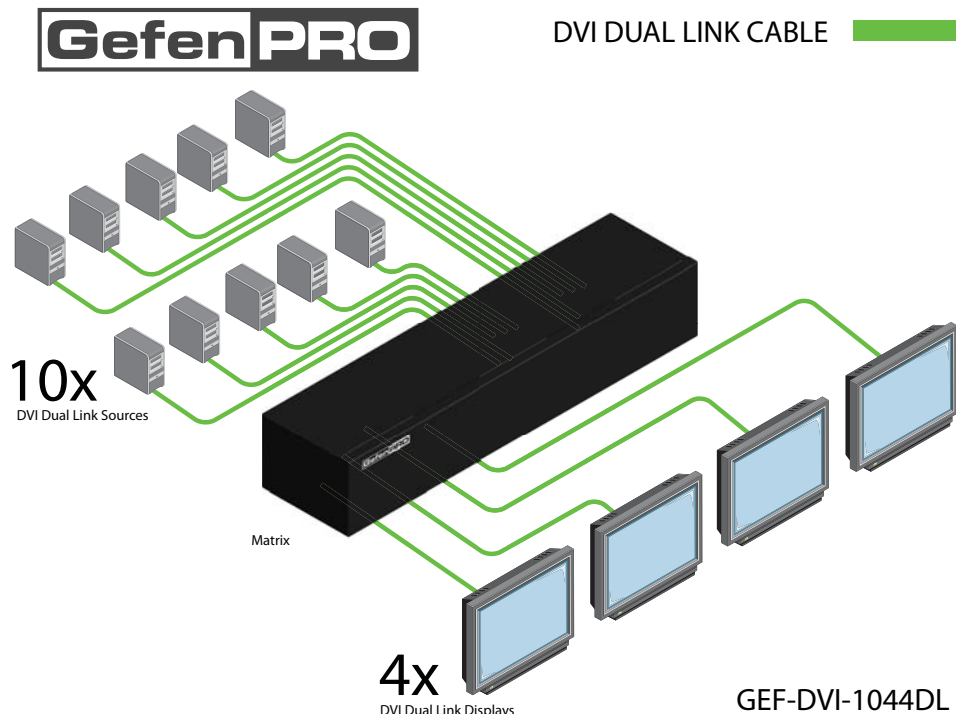

Attention: This product should always be connected to a grounded electrical socket.

CONNECTING AND OPERATING THE 10X4 DVI DUAL LINK MATRIX

Front Panel Controls

The GefenPRO 10x4 DVI Dual Link Matrix uses an LED display that shows the current routing status and is used to control the Matrix. When the unit is powered, four (4) LEDs will indicate the current routing status:

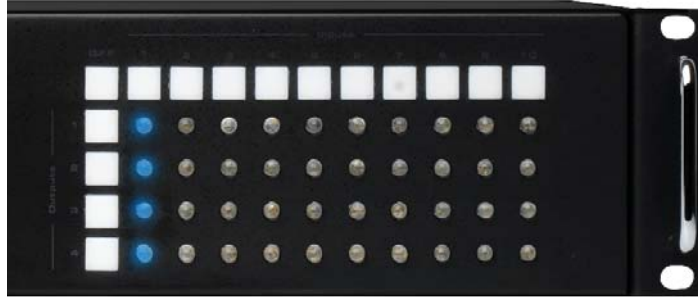

In the example above, all DVI sources have been routed to Output 1.

The top row of ten (10) buttons correspond to each input on the Matrix. The four buttons on the left correspond to each of the outputs on the Matrix (see pages 4 and 5).

The GefenPRO 10x4 DVI Dual Link Matrix can route a source to one monitor at a time or a source to multiple monitors at once. Routing a source to a monitor is a two-step process: The first step is to select the monitor (1-4) to which the source will be routed. The second step is to select the source (1-10).

Routing a Source to a Monitor

Example 1:

Route the source device connected to In 2 to the monitor connected to Out 1.

1. Press the Output 1 button. The Output 1 button will glow blue, indicating that it has been pressed.

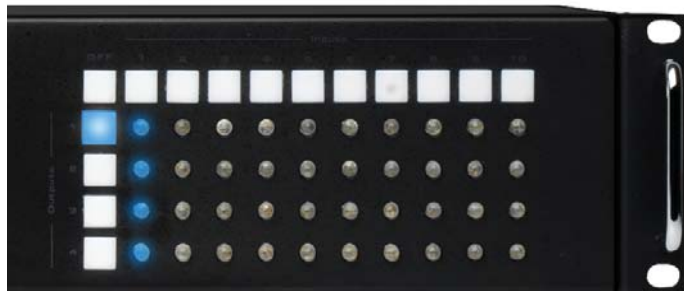

CONNECTING AND OPERATING THE 10X4 DVI DUAL LINK MATRIX

2. Press the Input 2 button.

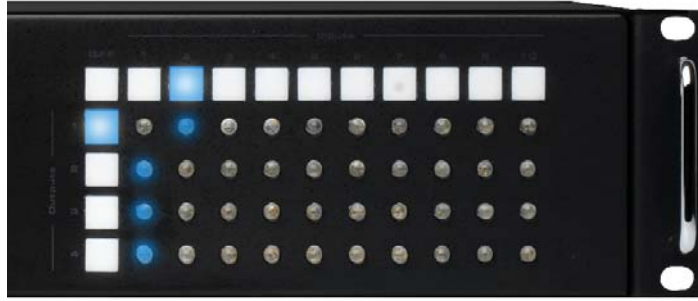

The Input 2 button will glow blue momentarily and the LED will change from Input 1 to Input 2.

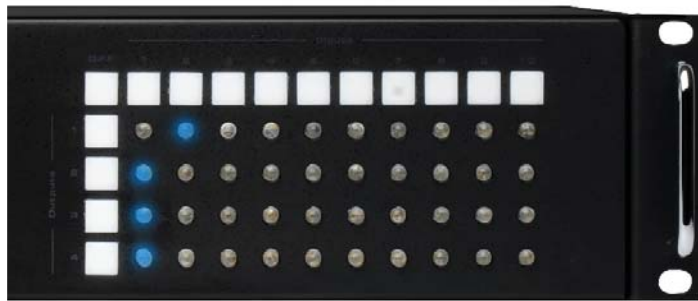

The Input 2 and for Output 1 buttons will turn off. The source connected to Input 2 should now be displayed on the monitor connected to Output 1.

Routing a Source to Multiple Monitors at Once

Example 2:

Route the source device connected to In 3 to the monitors connected Out 2, Out3, and Out4.

1. Press the buttons for Output 2, Output 3, and Output 4. Each button will glow blue, indicating that it has been pressed.

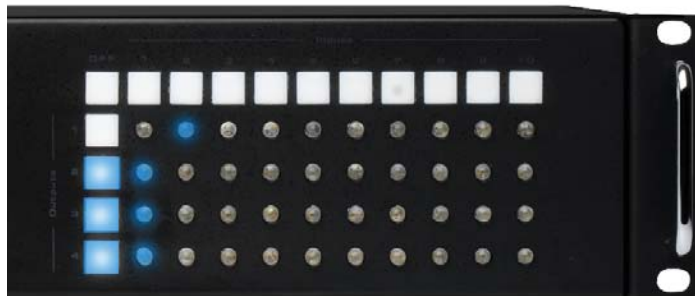

CONNECTING AND OPERATING THE 10X4 DVI DUAL LINK MATRIX

2. Press the button for Input 3.

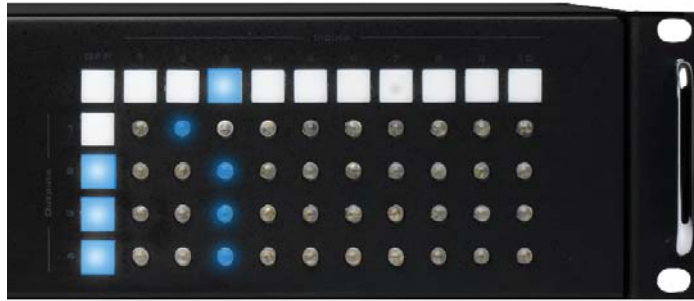

The button for Input 3 will glow blue momentarily and each LED will change from Input 1 to Input 3.

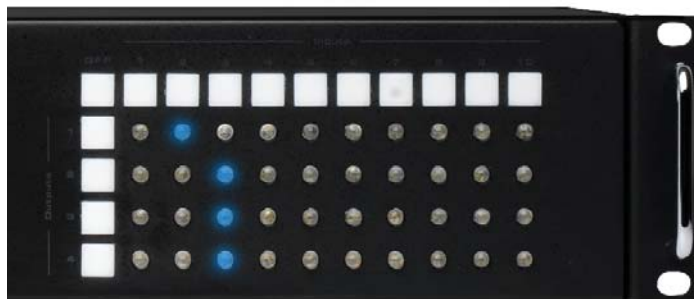

In the example above, Input 3 has been routed to Outputs 2, 3, and 4. From the previous example (see page 9), Input 2 has been routed to Output 1.

CONNECTING AND OPERATING THE 10X4 DVI DUAL LINK MATRIX

Masking Outputs

Any monitor can be blocked (masked) from displaying video. A single monitor or multiple monitors can be masked at any one time.

Example 1:

Masking Output 2 and Output 3.

1. Press the buttons for Output 2 and Output 3. Each button will glow blue, indicating that it has been pressed.

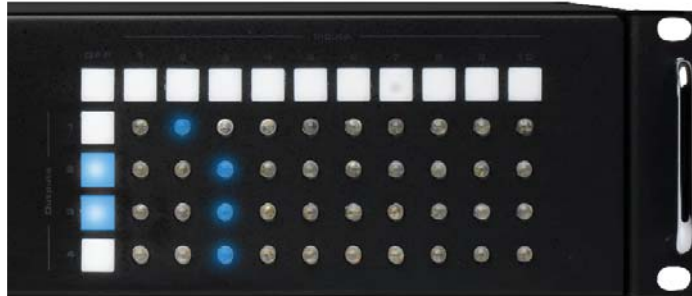

2. Press the Off button, located at the far-left of the Input buttons.

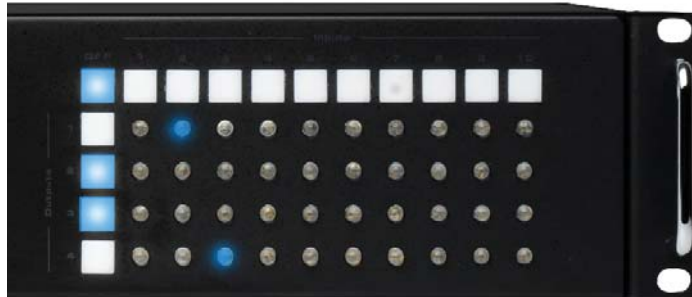

The Off button will glow blue momentarily.



The buttons for Output 2 and Output 3 will turn off and video will not be transmitted to Output 2 and Output 3.

CONNECTING AND OPERATING THE 10X4 DVI DUAL LINK MATRIX

Unmasking Outputs

Example 1:

Unmasking Output 2 and Output 3.

1. Press the buttons for Output 2 and Output 3. Each button will glow blue, indicating that it has been pressed.

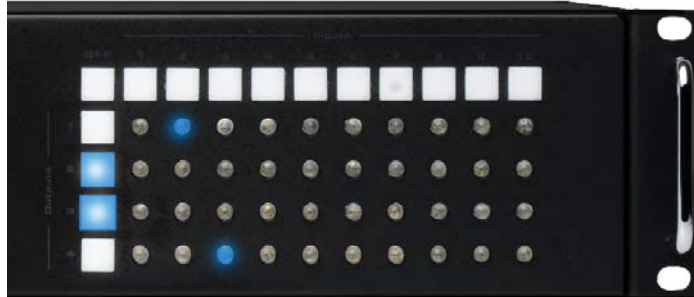

2. Press the Off button, located at the far-left of the Input buttons.

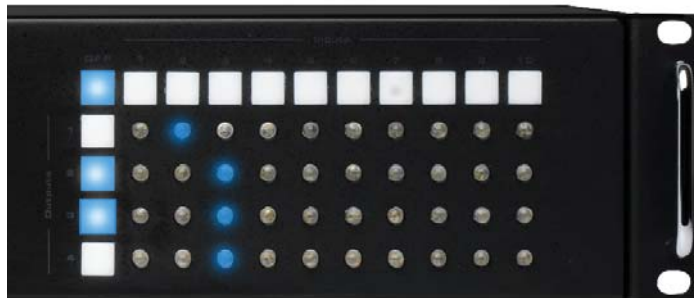

The Off button will glow blue momentarily and the LED indicators for Output 2 and Output 3 will glow blue.



The Off, Output 2, and Output 3 buttons will turn off and video should now be restored to monitor 2 and monitor 3.

IR REMOTE DESCRIPTION

RMT-16416IR Remote Control Unit

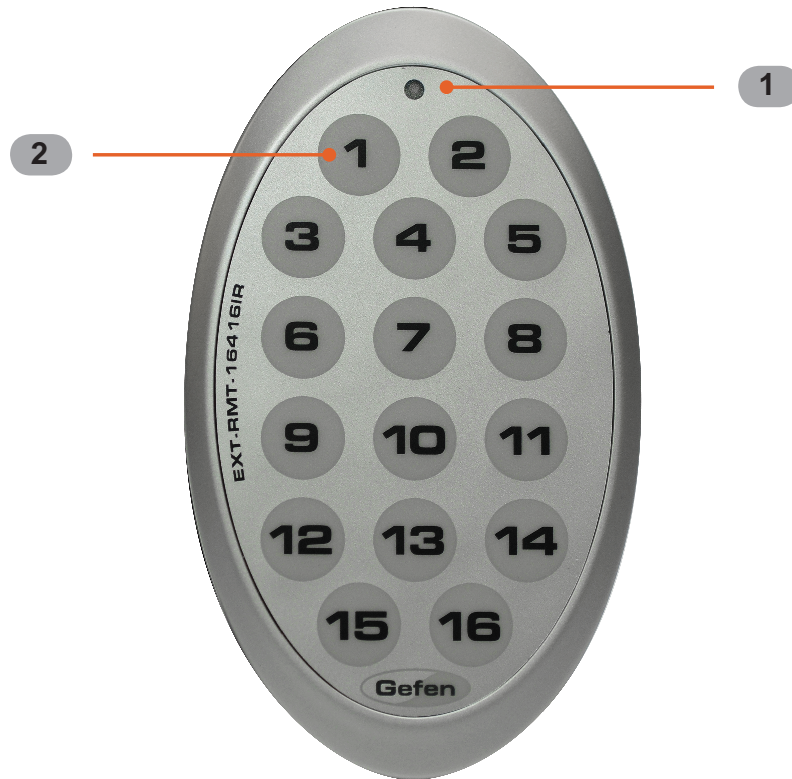

1 Activity Indicator

This LED will be activated momentarily each time a button is pressed.

2 Display and Source Selection Buttons

These buttons are used to select which source is routed to a monitor.

Routing Sources using the Remote Control unit

Issuing a routing command is a two step process. The first step is to select the monitor (1-4) to which the source will be routed. The second step is to select the source (1-10).

Example:

Route the source device connected to In 6 to the monitor connected to Out 4.

1. Press button 4 (Out 4) on the IR remote control unit.
2. Press button 6 (In 6) on the IR remote control unit.

The source connected to In 6 will be routed to the monitor connected to Out 4.

IR REMOTE INSTALLATION

Installing the IR Remote Control Battery

1. Remove the battery cover on the back of the IR Remote Control unit.
2. Insert the included battery into the open battery slot. The positive (+) side of the battery should be facing up.
3. Replace the battery cover.

The Remote Control unit ships with two batteries. One battery is required for operation and the other battery is a spare.

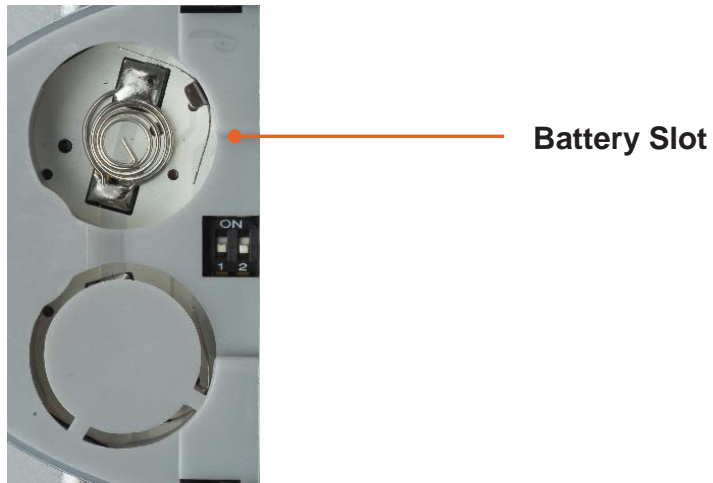

CAUTION: Risk of explosion if battery is replaced by an incorrect type. Dispose of used batteries according to the instructions.

IR REMOTE CONFIGURATION

How to Resolve IR Code Conflicts

In the event that IR commands from other remote controls interfere with the supplied IR Remote Control unit, changing the IR channel on the IR Remote Control unit will fix the problem. The IR Remote Control unit has a bank of DIP switches used for setting the IR channel.

The DIP switch bank is located underneath the battery cover.

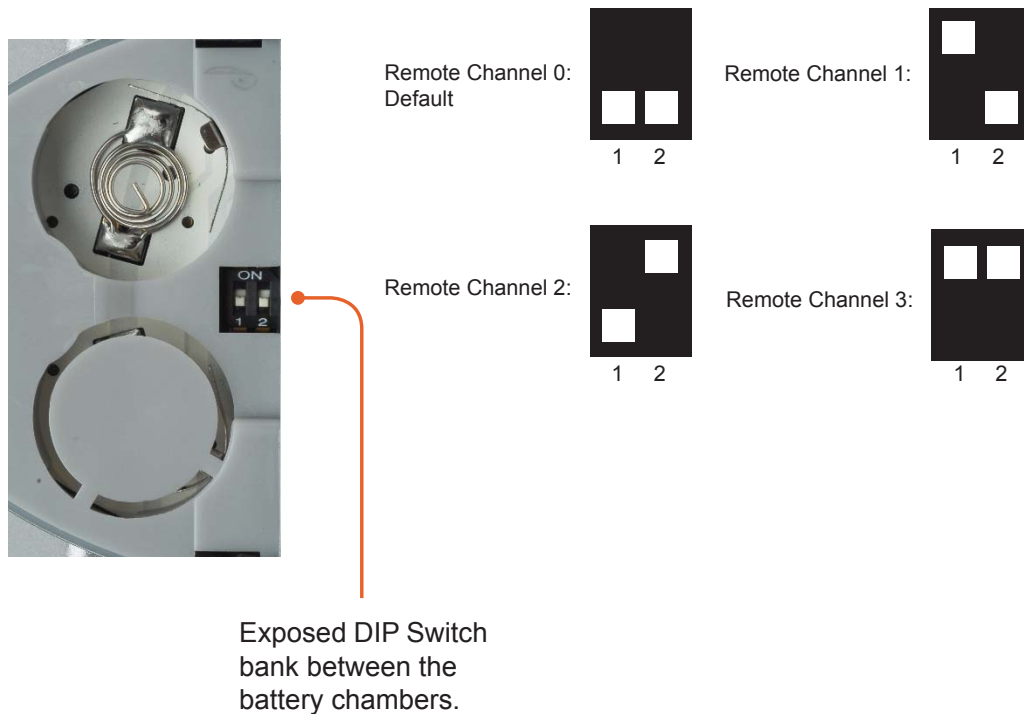

It is important that the IR channel on the Remote Control unit, matches the IR channel set on the 10x4 DVI Dual Link Matrix. For example, if both DIP switches on the IR Remote Control unit are set to IR channel 0 (both DIP switches down), then the 10x4 DVI Dual Link Matrix must also be set to IR channel 0. See page 30 on how to change the IR channel on the 10x4 DVI Dual Link Matrix.

EDID MANAGEMENT FEATURE

EDID. What is it and what is it used for?

Under normal circumstances, a source device (digital and analog) will require information about a connected device/display to assess what resolutions and features are available. The source can then tailor its output to send only resolutions and features that are compatible with the attached device/display. This information is called EDID (Extended Display Information Data) and a source device can only accept and read one EDID from a connected device/display. Likewise, the source can only output one resolution for use by a connected device/display.

Why is EDID so important with the 10x4 DVI Dual Link Matrix?

The 10x4 DVI Dual Link Matrix is a complex piece of technology that replicates and switches between multiple inputs and outputs. Each connected source device will require one EDID to read. EDID management is carefully handled by the 10x4 DVI Dual Link Matrix to provide a single EDID for each source to read.

What options do I have to manage the EDID in the 10x4 DVI Dual Link Matrix?

First, it is important to note that each source device can only output one video/audio signal type. This includes resolutions and timings. When multiple devices/displays are used, such as with the 10x4 DVI Dual Link Matrix, it is important to use devices/displays that have similar or compatible resolutions and features. This will ensure that the single video/audio signal produced by the source device is accepted by all of the connected output devices/displays.

The user has the option, through utilization of the RS-232 serial interface, to choose how the unit will manage the EDID from multiple DVI devices/displays. Therefore the user has some control over the resolutions and features that the source devices will output. The 10x4 DVI Dual Link Matrix has a LOCAL EDID management mode that will control how the EDID information is handled.

How do I change EDID modes in the 10x4 DVI Dual Link Matrix?

EDID modes and IP configuration is managed via the RS-232 serial communications port. See page 18 for more information on the RS-232 serial communication features.

RS-232 SERIAL CONTROL

What features are available via the RS-232 serial communications port?

The 10x4 DVI Dual Link Matrix Switcher can accept commands through the RS-232 serial communications port located on the rear panel. The current RS-232 control features are:

- Switching/routing of inputs to outputs without the IR remote control.
- Managing the EDID bank and EDID that is loaded into the LOCAL EDID.
- Upload new EDID's to the EDID bank or directly to the LOCAL EDID location.
- Manage IP settings.

How do I use these features?

These features were initially intended for utilization by custom installers in automated setups. However, these features can be tested and used by using any Windows PC with a terminal program.

What pins are used for communication with the 10x4 DVI Dual Link Matrix Switcher?

Only pins 2 (Receive), 3 (Transmit), and 5 (Ground) are used for communication. A null-modem adapter should not be used with this product.



Only Pins 2 (RX), 3 (TX), and 5 (Ground) are used on the RS-232 serial interface

RS-232 Settings

Bits per second	19200
Data bits	8
Parity	None
Stop bits	1
Flow Control	None

RS-232 SERIAL CONTROL

RS-232 Features

RS-232 remote functions are used to control of this product's features. Features include input to output routing, EDID storage, EDID management, etc. These functions are available only through the use of the serial port.

Functions Syntax

The syntax for each function is always the same:

Character as the start flag → Function name → Space (_) as function name end flag → Parameter 1 → Space → Parameter n → Carriage Return (\r) →

Sample:

```
#FunctionName_param1_param2_param3_param4...\r
```

Syntax is NOT case sensitive.

Function list

EDID Management

Function	Description
<i>#EDIDDSTOLO</i>	Read downstream EDID and stores into a Local EDID
<i>#EDIDDSTOBA</i>	Read downstream EDID and stores in EDID Bank
<i>#EDIDBATOLO</i>	Read downstream EDID and stores in any Local Input
<i>#EDIDDETOLO</i>	Sets Local EDID to Default EDID
<i>#LOCKEDID</i>	Secures Local EDID
<i>#LOEDIDTOLO</i>	Load EDID file using serial port to one of the local memories
<i>#PRLOEDID</i>	Read Input Local EDID and sends to serial port
<i>#PRDSEDID</i>	Read downstream EDID and sends to serial port
<i>#PRBAEDID</i>	Read downstream EDID from bank and sends to serial port
<i>#PREDIDST</i>	Prints EDID details

RS-232 SERIAL CONTROL

#EDIDDSTOLO Function

The #EDIDDSTOLO function reads the downstream EDID and stores it to a Local EDID input.

Syntax:

```
#EDIDDSTOLO param1 param2 [param3...param9]
```

Parameters:

<i>param1</i>	A downstream monitor	[1 - 4]
<i>param2</i>	Input list	[1 - 10]

Notes:

If *param2* = 0, then the downstream EDID is stored to all 10 DVI inputs.

Examples:

```
#EDIDDSTOLO 2 1 2 3 4 5    inputs 1-5 use display 2 EDID
#EDIDDSTOLO 3 0           all inputs use display 3 EDID
```

#EDIDDSTOBA Function

The #EDIDDSTOBA function reads the downstream EDID and stores it to a specified EDID bank.

Syntax:

```
#EDIDDSTOBA param1 param2
```

Parameters:

<i>param1</i>	A downstream monitor	[1 - 4]
<i>param2</i>	EDID bank offset	[1 - 5]

RS-232 SERIAL CONTROL

#EDIDBATOLO Function

The #EDIDBATOLO function reads the downstream EDID and stores it to any local input.

Syntax:

```
#EDIDBATOLO param1 param2 [param3...param9]
```

Parameters:

<i>param1</i>	EDID bank offset	[1 - 5]
<i>param2</i>	Input	[1 - 10]

Notes:

If *param2* = 0, then the EDID in the specified bank is copied to all eight inputs.

#EDIDDETOLO Function

The #EDIDDETOLO function stores the Default EDID (640x480) in the specified Local EDID inputs.

Syntax:

```
#EDIDDETOLO param1 param2 param3...param9
```

<i>param1</i>	Input	[1 - 10]
---------------	-------	----------

Notes:

If *param1* = 0, then all 10 DVI inputs will be set to the Default EDID.

RS-232 SERIAL CONTROL

#LOCKEDID Function

The #LOCKEDID function secures the Local EDID and disables the automatic loading of the downstream EDID after the Matrix is powered on.

Syntax:

```
#LOCKEDID param1
```

Parameters:

param1 Input [0 - 1]

Value	Meaning
0	Disable
1	Enable

#LOEDIDTOLO Function

The #LOEDIDTOLO function loads an external EDID via RS-232 to any Local EDID input bank.

Syntax:

```
#LOEDIDTOLO param1 param2 param3
```

Parameters:

param1 Input [1 - 10]

param2 EDID size [1 - 2]

Value	Meaning
1	128 byte EDID
2	256 byte EDID

param3 eco [0 - 1]

Notes:

Set *param1* to a value of 0 in order to specify all inputs. When using HyperTerminal, *param3* must be set to 1.

#PRDSEDID Function

The #PRDSEDID function reads the downstream EDID and sends it to the serial port.

Syntax:

```
#PRDSEDID param1
```

Parameters:

<i>param1</i>	A downstream monitor	[1 - 4]
---------------	----------------------	---------

#PRLOEDID Function

The #PRLOEDID function reads the local EDID of a specified input and spools it to the serial port.

Syntax:

```
#PRLOEDID param1
```

Parameters:

<i>param1</i>	A specified Input	[1 - 10]
---------------	-------------------	----------

#PRBAEDID Function

The #PRBAEDID function reads the EDID file from the specified bank and sends to serial port.

Syntax:

```
#PRBAEDID param1
```

Parameters:

<i>param1</i>	Input	[1 - 5]
---------------	-------	---------

#PREDIDST Function

The #PREDIDST function reads the downstream EDID. This function displays a table containing details relating to the Local EDID and the monitor name.

Syntax:

#PRDSEDID

Parameters:

None

IP Configuration

Function	Description
#PRWEBADD	Displays the Web configuration
#RSTIP	Set IP configuration to default
#SIPADD	Specifies a new IP address
#SNETMASK	Specifies a new net mask
#SGATEWAY	Specifies the new gateway
#SPORT	Specifies a new port

#PRWEBADD Function

The #PRWEBADD displays the IP address, net mask, gateway, MAC address, and port on the screen.

Syntax:

#PRWEBADD

Parameters:

None

#RSTIP Function

The #RSTIP function sets the IP configuration to the default settings.

Syntax:

#RSTIP

Parameters:

None

#SIPADD Function

The #SIPADD function specifies a new IP address.

Syntax:

#SIPADD param1 param2 param3 param4

Parameters:

<i>param1</i>	IP address	[0 - 255]
<i>param2</i>	IP address	[0 - 255]
<i>param3</i>	IP address	[0 - 255]
<i>param4</i>	IP address	[0 - 255]

Notes:

A reboot is required after the new IP address is set.

RS-232 SERIAL CONTROL

#SNETMASK Function

The #SNETMASK function specifies a new net mask.

Syntax:

```
#SNETMASK param1 param2 param3 param4
```

Parameters:

<i>param1</i>	IP address	[0 - 255]
<i>param2</i>	IP address	[0 - 255]
<i>param3</i>	IP address	[0 - 255]
<i>param4</i>	IP address	[0 - 255]

Notes:

A reboot is required after the new IP address is set.

#SGATEWAY Function

Specifies the new IP gateway.

Syntax:

```
#SGATEWAY param1 param2 param3 param4
```

Parameters:

<i>param1</i>	Gateway address	[0 - 255]
<i>param2</i>	Gateway address	[0 - 255]
<i>param3</i>	Gateway address	[0 - 255]
<i>param4</i>	Gateway address	[0 - 255]

Notes:

A reboot is required after the gateway address has been assigned.

#SPORT Function

Specifies a new port.

Syntax:

```
#SPORT param1
```

Parameters:

<i>param1</i>	Port	[0 - 255]
---------------	------	-----------

Notes:

A reboot is required after the gateway address has been assigned.

#PRWEBADD Function

Prints the current IP configuration on the screen.

Syntax:

```
#PRWEBADD
```

Parameters:

None

Notes:

A reboot is required after the gateway address has been assigned.

RS-232 SERIAL CONTROL

General Functions

Function	Description
#ACTIVEBOLO	Enables the boot loader
#FADEFAULT	Set matrix local and routing status to default settings
#LOCKPOWER	Toggles the lock power state
#MASKOUT	Blanks selected outputs
#RMTIRADD	Set the remote IR channel
#STBYMODE	Sets the Matrix to Standby Mode

#ACTIVEBOLO Function

The #ACTIVEBOLO function enables the boot loader allowing the Matrix to be updated with firmware using RS-232.

Syntax:

#ACTIVEBOLO

Parameters:

None

Notes:

The #ACTIVEBOLO command must be typed twice in order to activate the boot loader.

#FADEFAULT Function

The #FADEFAULT function sets all Local EDIDs and routing settings to default.

Syntax:

#FADEFAULT

Parameters:

None

RS-232 SERIAL CONTROL

#LOCKPOWER Function

The #LOCKPOWER enables/disables the power lock state. Enabling this feature will store the 5V status for each input prior to shutting the unit down. This preserves the 5V state when the Matrix is restarted.

Syntax:

```
#LOCKPOWER param1
```

Parameters:

param1 State [0 - 1]

Value	Meaning
0	Disable Power Lock
1	Enable Power Lock

#MASKOUT Function

The #MASKOUT function allows blanking or selected outputs.

Syntax:

```
#MASKOUT param1 param2
```

Parameters:

param1 Output [1 - 4]

param2 Output [1 - 4]

Notes:

The current masking state will be lost if power is lost.

#RMTIRADD Function

The #RMTIRADD function set the remote IR channel.

Syntax:

```
#RMTIRADD param1
```

Parameters:

param1 IR channel [0 - 3]

#STBYMODE Function

The #STBYMODE function disables / enables standby power mode.

Syntax:

```
#STBYMODE param1
```

Parameters:

param1 Disable / Enable [0 - 1]

Value	Meaning
0	Disable Standby Mode
1	Enable Standby Mode

RS-232 SERIAL CONTROL

Commands

Command	Description
<i>R</i>	Routing command
<i>S</i>	Routes a single input to all outputs
<i>M</i>	Returns the current routing status of matrix
<i>F</i>	Toggle 5V fiber optic extender feature

R Command

The R command allows specific routing of inputs and outputs.

Syntax:

```
r param1 param2
```

Parameters:

<i>param1</i>	DVI Output	[1 - 4]
<i>param2</i>	DVI Input	[1 - 10]

S Command

The S command routes a single input to all 10 DVI outputs.

Syntax:

```
s param1
```

Parameters:

<i>param1</i>	Input	[1 - 10]
---------------	-------	----------

Notes:

Setting *param1* to a value of 0 will place the matrix in *one-to-one mode*. This means that Input 1 will be routed to Output 1, Input 2 will be routed to Output 2, and so on.

M Command

The M command displays the current routing status of the matrix.

Syntax:

m

Parameters:

None

F Command

The F command returns the state of pin 14 of the DVI inputs.

Syntax:

f param1 param2

Parameters:

<i>param1</i>	DVI input	[1 - 10]
<i>param2</i>	State	[0 - 1]

Notes:

“High” is returned if +5V is enabled on the DVI input. “Low” is returned if +5V is disabled on the DVI input.

MANAGE EDID

Gefen 16x16 DVI Manager

VIEW MATRIX STATUS **MANAGE EDID** MASKING IP CONFIGURATION BACKUP/RESTORE POWER MANAGEMENT

SET INPUT TO DEFAULT EDID UPLOAD EDID DOWNLOAD EDID COPY EDID EDID LOCK STATE

Refresh

Input	EDID Source	Name
1	Default	MATRIX
2	Default	MATRIX
3	Default	MATRIX
4	Default	MATRIX
5	Default	MATRIX
6	Default	MATRIX
7	Default	MATRIX
8	Default	MATRIX
9	Default	MATRIX
10	Default	MATRIX
11	Default	MATRIX
12	Default	MATRIX
13	Default	MATRIX
14	Default	MATRIX
15	Default	MATRIX
16	Default	MATRIX

Refresh

The **Manage EDID** page is used to see the status of the EDID saved in the local storage location for each input. This section has additional tabs for advanced EDID functions. These tabs are:

- SET INPUT TO DEFAULT EDID
- UPLOAD EDID (Future Implementation)
- DOWNLOAD EDID (Future Implementation)
- COPY EDID
- EDID LOCK STATE

This page will automatically refresh every minute. However, at anytime the REFRESH button can be pressed to return the current status of the Matrix.

SET INPUT TO DEFAULT EDID

Pressing the SET INPUT TO DEFAULT EDID button will display additional options. The following page will open.

The screenshot shows the 'Gefen 16x16 DVI Manager' web interface. At the top, there are navigation tabs: VIEW MATRIX STATUS, MANAGE EDID (selected), MASKING, IP CONFIGURATION, BACKUP/RESTORE, and POWER MANAGEMENT. Below these are action buttons: SET INPUT TO DEFAULT EDID (selected), UPLOAD EDID, DOWNLOAD EDID, COPY EDID, and EDID LOCK STATE. The main content area is divided into two sections. On the left, there is a table with columns 'Input', 'EDID Source', and 'Name'. The table shows 16 rows, all with 'Default' as the source and 'MATRIX' as the name. Above the table is a 'Refresh' button and below it is another 'Refresh' button. On the right, there is a section titled 'Select Input(s) to Set to Default:' with 16 checkboxes labeled 'Input 1' through 'Input 16'. Below the checkboxes is a 'Set Default EDID' button.

Input	EDID Source	Name
1	Default	MATRIX
2	Default	MATRIX
3	Default	MATRIX
4	Default	MATRIX
5	Default	MATRIX
6	Default	MATRIX
7	Default	MATRIX
8	Default	MATRIX
9	Default	MATRIX
10	Default	MATRIX
11	Default	MATRIX
12	Default	MATRIX
13	Default	MATRIX
14	Default	MATRIX
15	Default	MATRIX
16	Default	MATRIX

On this page, local memory locations can be selected to receive the built-in EDID stored in the 10x4 DVI Dual Link Matrix. To set an input's local memory location to the default EDID follow the steps below.

1. Select any number of inputs by clicking on the desired checkboxes.
2. Click on the **Set Default EDID** button to update the change(s).

Note: After this command is complete the Web Interface will return to the VIEW MATRIX STATUS page.

This page will automatically refresh every minute. However, the REFRESH button can be pressed at any time to return the current status of the Matrix.

COPY EDID

Pressing the COPY EDID button will display additional options. The following page will open.

The screenshot shows the 'Gefen 16x16 DVI Manager' interface. At the top, there are navigation tabs: VIEW MATRIX STATUS, MANAGE EDID (selected), MASKING, IP CONFIGURATION, BACKUP/RESTORE, and POWER MANAGEMENT. Below these are action buttons: SET INPUT TO DEFAULT EDID, UPLOAD EDID, DOWNLOAD EDID, COPY EDID (selected), and EDID LOCK STATE. The main area is divided into three sections:

- EDID Status - Lock State: OFF**: A table with columns 'Input', 'EDID Source', and 'Name'. It lists 16 inputs, all with 'Default' source and 'MATRIX' name.
- Select Source to Copy from:**: Two rows of radio buttons for 'Output 1' through 'Output 16' and 'Input 1' through 'Input 16'.
- Select Input(s) to Copy to:**: Two rows of checkboxes for 'Input 1' through 'Input 16'.

A 'Set EDID' button is located below the 'Select Input(s) to Copy to' section. There are 'Refresh' buttons above the table and below the input selection area.

On this page, the user can select an EDID from either the local memory locations (Input) or from a monitor that is currently attached to any output and copy that EDID to any other LOCAL memory location. This will permit control of what EDID information will be passed to each source connected to the 10x4 DVI Dual Link Matrix.

To copy an EDID follow the steps below.

1. Select an EDID from the **Select Source to Copy from** section. An EDID can be selected from a monitor connected to one of the outputs or from an EDID already loaded into one of the local memory locations (Input). It should be noted that only one EDID can be selected for copying.
2. Select the local memory locations that will receive the selected EDID under the **Select Input(s) to Copy to** section. Multiple local memory locations can be specified during this step.
3. Click on the **Set EDID** button to initiate the change(s).

This page will automatically refresh every minute. However, at anytime the **Refresh** button can be pressed to refresh the status of the Matrix.

NOTICE: UPLOAD EDID and DOWNLOAD EDID features are not supported at the time of this writing.

EDID LOCK STATE

The 10x4 DVI Dual Link Matrix allows the Local EDID to be preserved after the unit has been powered off. Once enabled, this will function will prevent the 10x4 DVI Dual Link Matrix from reading the EDID of a monitor, when the matrix is powered on.

The screenshot shows the Gefen 16x16 DVI Manager web interface. At the top, there are navigation tabs: VIEW MATRIX STATUS, MANAGE EDID, MASKING, IP CONFIGURATION, BACKUP/RESTORE, and POWER MANAGEMENT. Below these are action buttons: SET INPUT TO DEFAULT EDID, UPLOAD EDID, DOWNLOAD EDID, COPY EDID, and EDID LOCK STATE. The EDID LOCK STATE button is highlighted. The main content area shows the EDID Lock State configuration. It includes a table with columns: Input, EDID Source, Name, and Connected?. The table lists 16 rows, all with 'Output 1' as the EDID Source, 'M40' as the Name, and 'YES' as the Connected? status. To the right of the table, there is a section titled 'EDID Lock State' with a label 'Update EDID Lock State' and two radio buttons: 'Off' and 'On'. The 'Off' radio button is selected.

Input	EDID Source	Name	Connected?
1	Output 1	M40	YES
2	Output 1	M40	YES
3	Output 1	M40	YES
4	Output 1	M40	YES
5	Output 1	M40	YES
6	Output 1	M40	YES
7	Output 1	M40	YES
8	Output 1	M40	YES
9	Output 1	M40	YES
10	Output 1	M40	YES
11	Output 1	M40	YES
12	Output 1	M40	YES
13	Output 1	M40	YES
14	Output 1	M40	YES
15	Output 1	M40	YES
16	Output 1	M40	YES

The EDID Lock State can be enabled (ON) or disabled (OFF). The EDID Lock State is used.

1. Once the Local EDID has been stored, press the EDID LOCK STATE web button.
2. Select the ON radio button from the dialog and press Update EDID Lock State.

The 10x4 DVI Dual Link Matrix can be powered-down and the Local EDID will be preserved. To disable the EDID LOCK STATE feature, select the OFF radio button in the Web interface and press the Update EDID Lock State button. Once the EDID LOCK STATE has been disabled (OFF), the 10x4 DVI Dual Link Matrix will read and use the EDID of the monitor connected to the matrix.

MASKING

Gefen 16x16 DVI Manager

VIEW MATRIX STATUS MANAGE EDID **MASKING** IP CONFIGURATION BACKUP/RESTORE POWER MANAGEMENT

Refresh

Output	Input	Status
1	1	Active
2	1	Active
3	1	Active
4	1	Active
5	1	Active
6	1	Active
7	1	Active
8	1	Active
9	1	Active
10	1	Active
11	1	Active
12	1	Active
13	1	Active
14	1	Active
15	1	Active
16	1	Active

Refresh

Mask Outputs

Outputs

Output 1 Active Mask Output 2 Active Mask Output 3 Active Mask Output 4 Active Mask

Output 5 Active Mask Output 6 Active Mask Output 7 Active Mask Output 8 Active Mask

Output 9 Active Mask Output 10 Active Mask Output 11 Active Mask Output 12 Active Mask

Output 13 Active Mask Output 14 Active Mask Output 15 Active Mask Output 16 Active Mask

Submit

The **Masking** page is used to hide an output from displaying any video. From this page, all outputs can be set to “Active” or “Mask”. When an output is set to “Active”, it will function normally. When an output is set to “Mask”, it will not output any video. To set the “Active” or “Mask” mode, follow the steps below.

1. Select either “Active” or “Mask” for any number of desired outputs.
2. Press the “Submit” button to initiate the change(s).

After this command is complete the user will be returned to the **Main Page**.

This page will automatically refresh every minute, however, at anytime the “Refresh” button can be pressed to refresh the status of the matrix.

NOTE: All masked outputs will become active if the unit is power-cycled.

IP CONTROL - CONFIGURATION

IP CONFIGURATION

Gefen® 16x16 DVI Manager

VIEW MATRIX STATUS MANAGE EDID MASKING **IP CONFIGURATION** BACKUP/RESTORE POWER MANAGEMENT

MAC Address	IP Address	Subnet	Gateway	Port
0:1C:91:1:0:1C	192.168.2.26	255.255.255.0	192.168.2.1	80

Refresh

Change IP Settings

IP Address: (default: 192.168.0.70)
Subnet: (default: 255.255.255.0)
Gateway: (default: 192.168.0.1)
Port: (default: 80)

Save Reset IP Configuration to Defaults:

The **IP Configuration** page is used to set the IP settings that will be used to access the Web interface. The following items can be configured from this menu.

- IP Address (Default: 192.168.0.70)
- Subnet (Default: 255.255.255.0)
- Gateway (192.168.0.1)
- Port (Default: 80)

To change these settings follow the steps below.

1. Enter the desired network information into the fields provided.
2. Press the “Save” button to initiate the change(s).

Note: After this command is complete the user will be returned to the **Main Page**. Setting made on this page will not take effect until the unit is restarted. Please disconnect power from the unit and reconnect power for changes to take effect.

At anytime, the “Reset” button can be pressed to return the IP settings to their defaults.

BACKUP/RESTORE

Gefen 16x16 DVI Manager

VIEW MATRIX STATUS MANAGE EDID MASKING IP CONFIGURATION **BACKUP/RESTORE** POWER MANAGEMENT

This feature will be implemented in a future release.

Backup:
[Download Current Settings to File](#)

Restore:
Upload Configuration File:

The **Backup/Restore** page is used to backup and restore complete setup configurations.

Note: This feature will be implemented in a future release.

POWER MANAGEMENT

Gefen 16x16 DVI Manager

VIEW MATRIX STATUS MANAGE EDID MASKING IP CONFIGURATION BACKUP/RESTORE **POWER MANAGEMENT**

Power Status	
Port	1 2 3 4 5 6 7 8 9 10 11 12 13 14 15 16
Input	0v 0v 0v 0v 0v 0v 0v 0v 0v 0v 0v 0v 0v 0v 0v 0v

5V to Inputs

Input 1 5v Off 5v On Input 2 5v Off 5v On Input 3 5v Off 5v On Input 4 5v Off 5v On
Input 5 5v Off 5v On Input 6 5v Off 5v On Input 7 5v Off 5v On Input 8 5v Off 5v On
Input 9 5v Off 5v On Input 10 5v Off 5v On Input 11 5v Off 5v On Input 12 5v Off 5v On
Input 13 5v Off 5v On Input 14 5v Off 5v On Input 15 5v Off 5v On Input 16 5v Off 5v On

The **Power Management** page is used to set optional +5V power on an input to power specific optional devices. The current status of this feature for each input can be viewed on this page. To set this feature for each input follow the steps below.

1. Select the +5V option, either “On” or “Off” for each desired input.
2. Click on the “Update” button to initiate the change(s).

Note: After this command is complete the user will be returned to the **Main Page**.

This page will automatically refresh every minute, however, at anytime the “Refresh” button can be pressed to refresh the status of the matrix.

FIRMWARE UPDATE

FIRMWARE UPDATE PROCEDURE

To Begin the update procedure the unit's Boot Loader must be activated. To activate the Boot Loader please follow the procedure below:

If the unit is already powered on, the following RS-232 command can be used to activate the Boot Loader:

1. Connect RS-232 cable to PC and activate the Hyper Terminal program.
2. Type the command: #ACTIVEBOLO\r
3. Re-type the command: #ACTIVEBOLO\r

If the unit is not powered on, follow the instructions below to activate the Boot Loader:

1. Connect RS-232 cable to PC and activate the Hyper Terminal program.
2. Make sure Hyperterminal is set to the following:
 - a. Baud rate = 19200
 - b. Stop bits = 1
 - c. Data bits = 8
 - d. Flow control = None
3. Press the following three buttons on the front panel of the 10x4 simultaneously, while powering-on the unit:
 - a. select
 - b. < (left cursor)
 - c. > (right cursor)

Once the Boot Loader is activated the following message should appear:

```
DVI10x4 Boot Loading
===== Main Menu =====
Download new program to the temporary memory ----- 1
Copy new program to main memory ----- 2
Execute the new program ----- 3
=====
```

FIRMWARE UPDATE

Follow the on-screen instructions to complete the firmware update process:

1. Press [1] on the computer keyboard to begin downloading program to the temporary memory.

2. A message will appear in Hyperterminal:

```
Waiting for the file to be sent ... (press 'a' to abort)
```

3. In Hyperterminal, click Transfer > Send File...

4. Click Browse... and select the .BIN file to be uploaded (e.g. DVI10X4_uIP_4_80.bin)

5. Select Ymodem for the protocol.

6. Press Send on the Send File dialog box.

7. A message will appear in Hyperterminal:

```
Programming Completed Successfully!
```

8. Press [2] on the computer keyboard to begin copying the program to main memory. The next message will appear:

```
Memory copy, please wait .....
```

9. Wait until the copying process is finished. The next text will appear on the screen:

```
Memory copy, please wait ..... finished to copy
```

10. Press [3] on the computer keyboard and the new program will be executed.

RACK MOUNT SAFETY INFORMATION

- a. Maximum recommended ambient temperature: 45 °C
- b. Increase the air flow to maintain the temperature inside the rack.
- c. Install the product evenly to avoid mechanical overload.
- d. Connect an earthing wire between the an earthing stud and the grounding pin on the chassis.

SPECIFICATIONS

Video Amplifier Bandwidth	165 MHz per channel
Single Link Range	1920x1200
Dual Link Range.....	3840x2400
Input Video Signal	1.2 Volts p-p
IR Extender.....	3.5 mm Mini-Stereo
RS-232 Interface.....	DB-9 serial (F)
DVI Connector	DVI-I, 29-pin, female (digital only)
Power Supply.....	100 ~ 240 V AC (IEC Connector)
Power Consumption	90 Watts (max.)
Operating Temperature.....	0 °C ~ 45 °C / 32 °F ~ 104 °F
Storage Temperature.....	-20 °C ~ 60 °C / -4 °F ~ 140 °F
Relative Humidity.....	20% ~ 90% RH (no condensation)
Dimensions	17.25" W x 3.5" H x 12" D
Rack-mountable	2U rack space, rack ears included
Shipping Weight	29 lbs.
Certifications.....	UL (power supply), RoHS, CE

WARRANTY

Gefen warrants the equipment it manufactures to be free from defects in material and workmanship.

If equipment fails because of such defects and Gefen is notified within two (2) years from the date of shipment, Gefen will, at its option, repair or replace the equipment, provided that the equipment has not been subjected to mechanical, electrical, or other abuse or modifications. Equipment that fails under conditions other than those covered will be repaired at the current price of parts and labor in effect at the time of repair. Such repairs are warranted for ninety (90) days from the day of reshipment to the Buyer.

This warranty is in lieu of all other warranties expressed or implied, including without limitation, any implied warranty or merchantability or fitness for any particular purpose, all of which are expressly disclaimed.

1. Proof of sale may be required in order to claim warranty.
2. Customers outside the US are responsible for shipping charges to and from Gefen.
3. Copper cables are limited to a 30 day warranty and cables must be in their original condition.

The information in this manual has been carefully checked and is believed to be accurate. However, Gefen assumes no responsibility for any inaccuracies that may be contained in this manual. In no event will Gefen be liable for direct, indirect, special, incidental, or consequential damages resulting from any defect or omission in this manual, even if advised of the possibility of such damages. The technical information contained herein regarding the features and specifications is subject to change without notice.

For the latest warranty coverage information, refer to the Warranty and Return Policy under the Support section of the Gefen Web site at www.gefen.com.

PRODUCT REGISTRATION

Please register your product online by visiting the Register Product page under the Support section of the Gefen Web site.

LICENSING

lwIP is licenced under the BSD licence:

Copyright (c) 2001-2004 Swedish Institute of Computer Science.
All rights reserved.

Redistribution and use in source and binary forms, with or without modification, are permitted provided that the following conditions are met:

1. Redistributions of source code must retain the above copyright notice, this list of conditions and the following disclaimer.
2. Redistributions in binary form must reproduce the above copyright notice, this list of conditions and the following disclaimer in the documentation and/or other materials provided with the distribution.
3. The name of the author may not be used to endorse or promote products derived from this software without specific prior written permission.

THIS SOFTWARE IS PROVIDED BY THE AUTHOR ``AS IS'' AND ANY EXPRESS OR IMPLIED WARRANTIES, INCLUDING, BUT NOT LIMITED TO, THE IMPLIED WARRANTIES OF MERCHANTABILITY AND FITNESS FOR A PARTICULAR PURPOSE ARE DISCLAIMED. IN NO EVENT SHALL THE AUTHOR BE LIABLE FOR ANY DIRECT, INDIRECT, INCIDENTAL, SPECIAL, EXEMPLARY, OR CONSEQUENTIAL DAMAGES (INCLUDING, BUT NOT LIMITED TO, PROCUREMENT OF SUBSTITUTE GOODS OR SERVICES; LOSS OF USE, DATA, OR PROFITS; OR BUSINESS INTERRUPTION) HOWEVER CAUSED AND ON ANY THEORY OF LIABILITY, WHETHER IN CONTRACT, STRICT LIABILITY, OR TORT (INCLUDING NEGLIGENCE OR OTHERWISE) ARISING IN ANY WAY OUT OF THE USE OF THIS SOFTWARE, EVEN IF ADVISED OF THE POSSIBILITY OF SUCH DAMAGE.



20600 Nordhoff St., Chatsworth CA 91311
1-800-545-6900 818-772-9100 fax: 818-772-9120
www.gefenpro.com support@gefenpro.com

